



Power Connector PC6 - Push & Pull Size X6 – 15kV



Plug straight Push & Pull



Connector straight Push&Pull



Socket Push & Pull

INTRODUCTION

Cavotec Connectors develops electrical connectors that improve performance and protect critical applications in demanding environments.

The Cavotec PC6-X6 size 15kV is a non-Ex rated medium voltage connector designed for frequent connections and disconnections. Designed with Cavotec Push & Pull system, it offers a safe way for connecting and disconnecting via an ergonomic push & pull handle which could be critical in case of emergency.

Cavotec X6, a safe and easy power supply device for applications such as:

- RTG cranes – Shore – Mining & tunnelling – Ports

Cavotec PC6 compact and light design was possible with Cavotec's MWT technology enabling smaller pins to take high current with a minimal voltage drop.

PRODUCT FEATURES

- Maximum voltage 15kV (400V in pilot circuit), currents up to 500A
- Up to 4 pole insulator assembly as standard covering cable sizes up to 240mm²
- IP66 (when connected or with covers closed)
- Standard ambient temperature: -40°C to +80°C or -40°F to +176°F
- Socket & connector connection with integrated cover operated by the push & pull arms
- Standard finishes: marine grade aluminium ISO 3522 - Hardware in stainless steel
- Push & Pull arm material: Bronze ISO 1338:1977
- Female contact, male pin and cable terminal material: silver plated copper
- Easy wiring with male and female insulators made in PTFE (Teflon)
- Interchangeable pins & female contacts without dismantling the connector
- All cable terminals suits for cables of class 5, IEC 60228
- Cable glands: Cavotec "onion ring" gasket and strain relief covering cable outer diameters from Ø 45 - 110 mm
- For termination of the cable terminals, industry approved termination kits for 15kV must be used. Termination kits may be supplied by Cavotec on request.
- Standard cable terminals for crimping with hexagonal crimping tool
- Back parts of insulators have to be filed with non-reenterable epoxy compound.

OPTIONAL FEATURES

- Plug cover: PCX-01616-006
- Finger protection female socket: PCX-21670-4X4L
- Termination kit Raychem 10-35mm², IXSU F3111: PEE-07062-850
- Termination kit Raychem 25-95mm², IXSU F3121: PEE-07062-860
- Termination kit Raychem 95-240mm², IXSU F3131: PEE-07062-880
- Wall mounting bracket for Connector: PCX-49X10-2002
- Finishes: Colour or non-colour anodizing / Clear coat or solid color painting
- Mechanical interlock through different type of key locking system & additional pilot pins or multipin signal pins
- Up to 18ch external fibre optics (butt joint)

SPECIAL TOOLS

Allen key 5 mm (PCX-93003-005)

Male pin Dia. 14, 16mm	Female contact Dia. 14, 16mm	Key width	Socket wrench (Part numb.)
PCX-11014-XXXX		18/19	PCX-92102-019
	PCX-12014-XXXX	21/23	PCX-92102-021
PCX-11016-082	PCX-12016-XXXX	21/23	PCX-92102-021



PLUG/INVERTED PLUG, STRAIGHT PUSH & PULL

No pins (P&E+pil)	Max. voltage phase / pilot	Pin Size (mm) Max. Amp	Weight kg	Cross section mm ² / Max rec. Amp	Plug: Male Pins Product Code
4+2	15000V/400V	16mm / 500A	11	25 mm ² / 125A*	PC6-SX04-M0250
				35 mm ² / 160A	PC6-SX04M0350
				50 mm ² / 200A	PC6-SX04-M0500
				70 mm ² / 250A	PC6-SX04-M0700
				95 mm ² / 300A	PC6-SX04-M0950
				120 mm ² / 350A	PC6-SX04-M1200
				150 mm ² / 420A	PC6-SX04-M1500
				185 mm ² / 480A**	PC6-SX04-M1850
240 mm ² / 500A**	PC6-SX04-M2400				

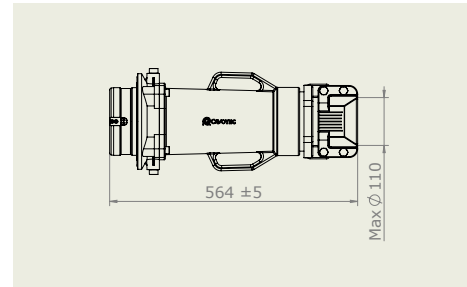

*For smaller sizes, please contact your local Cavotec sales office

** This option is only available if the cable core including termination doesn't exceed 34mm diameter

CONNECTOR/INVERTED CONNECTOR, STRAIGHT PUSH & PULL

No pins (P&E+pil)	Max. voltage phase / pilot	Pin Size (mm) Max. Amp	Weight kg	Cross section mm ² / Max rec. Amp	Connector: Female Contacts Product Code
4+2	15000V/400V	16mm / 500A	20	25 mm ² / 125A*	PC6-RX04-M0250
				35 mm ² / 160A	PC6-RX04-M0350
				50 mm ² / 200A	PC6-RX04-M0500
				70 mm ² / 250A	PC6-RX04-M0700
				95 mm ² / 300A	PC6-RX04-M0950
				120 mm ² / 350A	PC6-RX04-M1200
				150 mm ² / 420A	PC6-RX04-M1500
				185 mm ² / 480A**	PC6-RX04-M1850
240 mm ² / 500A**	PC6-RX04-M2400				

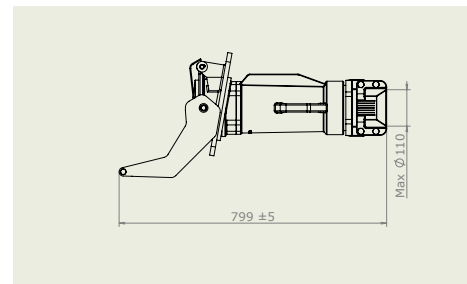

*For smaller sizes, please contact your local Cavotec sales office

** This option is only available if the cable core including termination doesn't exceed 34mm diameter

SOCKET/INVERTED SOCKET, PUSH & PULL



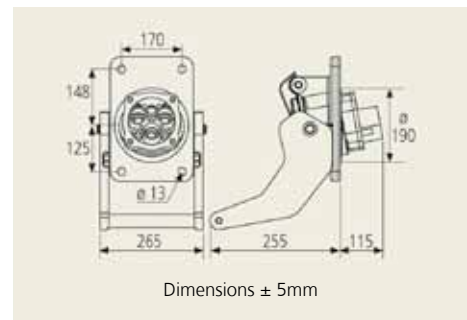













No pins (P&E+pil)	Max. voltage phase / pilot	Pin Size (mm) Max. Amp	Weight kg	Cross section mm ² / Max rec. Amp	Socket: Female Contacts Product Code
4+2	15000V/400V	16mm / 500A	13	25 mm ² / 125A	PC6-VX04-M0250
				35 mm ² / 160A	PC6-VX04-M0350
				50 mm ² / 200A	PC6-VX04-M0500
				70 mm ² / 250A	PC6-VX04-M0700
				95 mm ² / 300A	PC6-VX04-M0950
				120 mm ² / 350A	PC6-VX04-M1200
				150 mm ² / 420A	PC6-VX04-M1500
				185 mm ² / 480A**	PC6-VX04-M1850
240 mm ² / 500A**	PC6-VX04-M2400				



*For smaller sizes, please contact your local Cavotec sales office

** This option is only available if the cable core including termination doesn't exceed 34mm diameter

POWER CONNECTORS PRODUCT RANGE

Size	Connection type	Model name	Keying position	Accessories	Certifications	1-pole	3-pole	4-pole			5-pole	8-pole	13-pole	18-pole	25-pole	24, 30 & 37-pole	50-pole		
PC1	Screw Ring	S1	12								40A 690V 4mm ²	20A 415V 2,5mm ²	10A 230V 1,5mm ²	10A 230V 1,5mm ²					
	Screw Ring	S1	2, 4, 6, 8, 10, 12		ATEX & IECEx 						30A 690V 4mm ²	20A* 415V* 2,5mm ²	10A* 230V* 1,5mm ²	10A* 230V* 1,5mm ²					
PC2	Push&Pull	X2	2, 3, 4, 5, 6, 7, 8, 9, 10, 12 Insulator keying: 1-11	Low interlocking (PC2-VL) Wall bracket Screw terminals		660A 690V 300mm ²	250A 690V 70mm ²	200A 690V 50mm ²			200A 415V 50mm ²			40A 500V 4mm ²	40A 50V 4mm ²				
	Bayonet	B2	Double keying 1-11 55 options		ATEX & IECEx 	660A 690V 300mm ²	250A 690V 70mm ²	200A 690V 50mm ²			200A 415V 50mm ²			40A 500V 4mm ²	40A 50V 4mm ²				
PC3	Eye Bolt	K3						170A 1,1kV 50mm ²											
PC4	Push&Pull	X4	1, 2, 3, 4, 5, 6, 7, 8, 9, 10, 11, 12	External FO 6ch Screw terminals				250A 1,1kV 70mm ²			200A 1,1kV 70mm ²					40A 500V 4mm ²			
	Screw Ring	S4	1, 2, 3, 4, 5, 6, 7, 8, 9, 10, 11, 12	Short bell				250A 1,1kV 70mm ²			200A 1,1kV 70mm ²								
	Eye Bolt	K4						250A 1,1kV 70mm ²											
PC5	Push&Pull	X5	1, 2, 3, 4, 5, 6, 7, 8, 9, 10, 11, 12	External FO 12ch Internal FO 8ch Screw terminals Kirk Key interlock Wall bracket				420A 1,1kV 185mm ² Internal fiber optic	350A 7,2kV 150mm ² 								40A 500V 4mm ²		
	Screw Ring	S5	1, 2, 3, 4, 5, 6, 7, 8, 9, 10, 11, 12	Internal FO 8ch Screw terminals				420A 1,1kV 185mm ² Internal fiber optic	350A 7,2kV 150mm ²		350A 1,1kV 185mm ²								
PC6	Push&Pull	X6	6.12	External FO 18ch Internal FO 12ch Screw terminals Kirk Key interlock Wall bracket				660A 1,1kV 300mm ² Internal fiber optic	480A 7,2kV 240mm ² Internal fiber optic	500A 12kV 185mm ²	480A 1,1kV 300mm ²								
	Screw Ring	S6	6.12					660A 1,1kV 300mm ²			660A 1,1kV 300mm ²								
PC7	Eye Bolt	K7						400A 8kV 185mm ²											
PC8	Eye Bolt	K8						440A 15kV 120mm ²											
PC9	Eye Bolt	K9						440A 25kV 150mm ²											

*Available Q2 2015